

uitwerkbijlage

Naam kandidaat _____ Kandidaatnummer _____

12

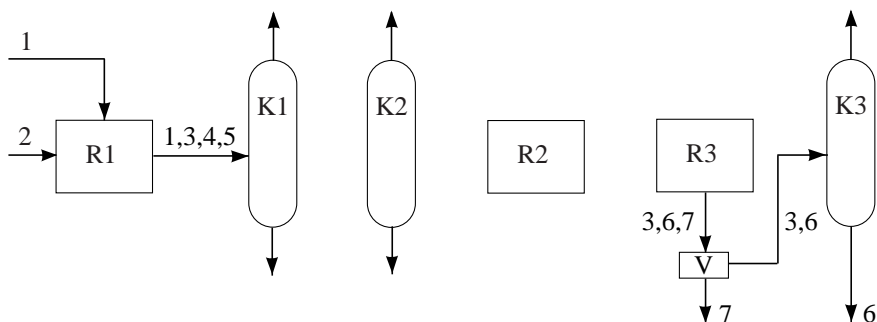

21

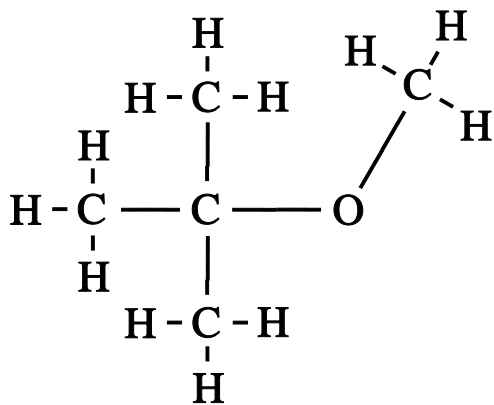

22

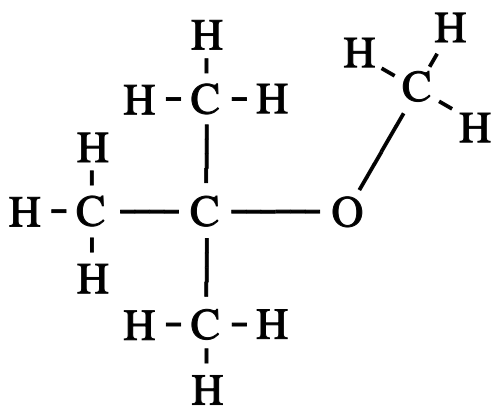

VERGEET NIET DEZE UITWERKBIJLAGE IN TE LEVEREN